



Australian Government
**Department of Industry, Science,
Energy and Resources**

National Measurement Institute

36 Bradfield Road, West Lindfield NSW 2070

Certificate of Approval **NMI 6/20A/6**

Issued by the Chief Metrologist under Regulation 60
of the
National Measurement Regulations 1999

This is to certify that an approval for use for trade has been granted in respect of the instruments herein described.

RDS Model Loadmaster Alpha 100 Wheeled Loader Weighing Instrument

submitted by Position Partners Pty Ltd
 (formerly RDS Australia Ltd)
 1075 Beaudesert Road
 Archerfield QLD 4108

NOTE: This Certificate relates to the suitability of the pattern of the instrument for use for trade only in respect of its metrological characteristics. This Certificate does not constitute or imply any guarantee of compliance by the manufacturer or any other person with any requirements regarding safety.

This approval has been granted with reference to document NMI R 51, *Automatic Catchweighing instruments*, dated August 2009.

This approval is subject to review at the decision of the Chief Metrologist in accordance with the conditions specified in the document NMI P 106.

DOCUMENT HISTORY

Rev	Reason/Details	Date
0	Pattern & variant 1 approved – variant 2 provisionally approved – interim certificate issued	20/03/15
1	Pattern & variant 1 approved – variant 2 cancelled – certificate issued	22/10/15
2	Variant 3 and 4 approved – certificate issued	19/04/17
3	Pattern amended (address & clause numbers) and variant 5 approved – certificate issued	10/05/19
4	Variant 6 approved – certificate issued	28/01/21
5	Pattern amended (interface clause reference) and variant 7 approved – certificate issued	04/05/22

CONDITIONS OF APPROVAL

General

Instruments purporting to comply with this approval shall be marked with pattern approval number 'NMI 6/20A/6' and only by persons authorised by the submittor.

It is the submittor's responsibility to ensure that all instruments marked with this approval number are constructed as described in the documentation lodged with the National Measurement Institute (NMI) and with the relevant Certificate of Approval and Technical Schedule. Failure to comply with this Condition may attract penalties under Section 19B of the National Measurement Act and may result in cancellation or withdrawal of the approval, in accordance with document NMI P 106.

Auxiliary devices used with this instrument shall comply with the requirements of General Supplementary Certificate of Approval No S1/0B.

This approval shall NOT be used in conjunction with General Certificate of Approval No 6B/0.

Special Conditions of Approval:

For this type of instrument, the ability to perform within the specified maximum permissible errors can depend substantially on characteristics of the wheeled loader to which it is fitted. Some designs of wheeled loaders simply may not be suitable for attachment of this weighing instrument, however the National Measurement Institute is unable to clearly define particular wheeled loaders, or categories of wheeled weighers, for which the instrument is unsuitable.

It is the responsibility of the submittor (RDS) to exercise control over any installation to ensure compliance with this approval and to ensure performance within the appropriate maximum permissible errors.

In the event of unsatisfactory performance this approval may be withdrawn.

Signed by a person authorised by the Chief Metrologist to exercise their powers under Regulation 60 of the *National Measurement Regulations 1999*.



Darryl Hines
Manager
Policy and Regulatory Services

TECHNICAL SCHEDULE No 6/20A/6

1. Description of Pattern **approved on 20/03/15**
amended on 04/05/22

The RDS model Loadmaster Alpha 100 class Y(b) automatic catchweighing instrument (Figure 1) of 12 500 kg maximum capacity with a verification scale interval of 50 kg fitted to a Komatsu model WA500-6 wheeled loader.

The RDS model Loadmaster Alpha 100 automatic catchweighing instrument comprises electronic equipment and sensors attached to a wheeled loader (i.e. typically 'front end loader') which automatically determine the load lifted by the lifting mechanism of the loader during the lifting process. Figure 1 shows a typical installation.

The electronic equipment and sensors are described below.

Instruments may be fitted with output sockets (output interfacing capability) for the connection of auxiliary and/or peripheral devices.

1.1 Pressure Sensor(s)

Up to four (4) Danfoss model MBS 1250 pressure sensors of 250 or 400 bar maximum range (Figure 2) are used, depending on the type of lifting system involved. The strain gauge type pressure sensors measure the pressure acting on the piston in the lift cylinder(s).

1.2 Temperature Sensor

The RDS Part No. S/SR/268-8-015 temperature sensor (Figure 3) is clamped to the outside of the pipe from the hydraulic control valve, connected to the main lift cylinder(s). The system is inhibited from working until the hydraulic fluid has reached a suitable operating temperature.

1.3 Boom Angle Sensor

A Pepperl+Fuchs model INY120D-F99-2I-1M-Y256827 inclination sensing device mounted to the boom measures the angular position of the boom relative to the reference (level) condition. The correct position for a weight determination is when the loading arm is passing within a weighing zone.

The direction of travel of the lifting arm (ascending or descending) is established by the signal change.

1.4 Load Receptor (Bucket) Location Sensor

The RDS Part No. S/SR/268-8-017 location sensor (Figure 4) is located to detect when the load receptor (bucket) is in the correct location (i.e. the bucket is fully rotated 'crowded' back, so that the load will fall into the centre of the bucket). The system will inhibit weighing if the load receptor is not in this location.

1.5 Boom Position Sensor (for Telescopic Loaders)

The RDS Part No. S/SR/268-8-017 location sensor (Figure 4), if required, is located to detect when the boom extension is in the correct location (i.e. the boom is fully retracted back). The system will inhibit weighing if the boom is not in this location.

1.6 Chassis Inclination Sensor

A Pepperl+Fuchs model INY120D-F99-2I-1M-Y256827 inclination sensing device attached to chassis of the vehicle (Figure 5) detects the degree to which the vehicle is tilted from its reference (level) condition, and allows the system to disable weight determination if 5 degrees of tilt is exceeded.

1.7 Weighing Module/Junction Box

The weighing module (Figure 6) houses all the terminations for transducers and sensors. It converts the transducers and sensors inputs into a digital weight value and the value is sent to the TERMINATOR junction box via CAN Bus.

The TERMINATOR junction box is located in the cabin and houses all the terminations for the battery, weighing module, ISOCAN control and display unit and peripheral devices.

1.8 Loadmaster ISOCAN Control and Display Unit

The Loadmaster ISOCAN control and display unit (Figure 7) has an LCD touchscreen display on which the weighing results as well as instructions, alarm or error messages are displayed.

1.9 Printer Unit

A Martel (aka RDS) model MCP7810 printing unit is attached to the terminator junction box and can print load tickets automatically or by manual command.

The printout will print information to identify the particular 'delivery' (a unique job number, time and date), the weight value of each load (lift), together with a total of the loads. Additional information may also be printed (product description, customer name, etc).

1.10 Additional Features

The system has certain additional functions:

- A function in which a particular target total weight is set. The material is delivered (e.g. loaded into a truck) by a number of lifts, and after each lift the display provides an indication of the material still to be delivered to obtain the target total weight.
- A totalisation facility.
- An 'auto enter' facility allowing each weight value to be automatically accepted (added to total and printed).
- A 'live last bucket' facility allowing adjustment of the final lift quantity. Once the quantity has been adjusted the load receptor must be lowered and re-lifted before the weight value is entered.
- Provision for storage of customer details.
- Provision for storage of product details.
- Provision for storage of pre-set target total values.
- Provision for storage of batch data (e.g. recipes of various target totals of different products).

The instrument may have other additional functions. These functions (other than the indications of measured mass - i.e. gross, tare, net, totals - displayed either on the indicator or on an auxiliary or peripheral device), are not approved for trade use.

1.11 Alternative Load Receptors

It is possible for the system to be calibrated with a number of different load receptors (i.e. different attachments to the lifting system). The system shall be verified for each different load receptor, and clear identification of the attachment shall be provided and shall correspond to the identification of the attachment in use which is indicated at the ISOCAN control and display unit.

Use with load receptors other than those with which the system has been verified is not approved.

1.12 Power Supply

The instrument is powered by the vehicle power supply (battery) of 12 or 24 V DC.

1.13 Zero

The instrument has a (dynamic) semi-automatic zero-setting device with a nominal range of not more than 4% of the maximum capacity of the instrument.

A zero setting operation, with a nominal range of not more than 4% of the maximum capacity of the instrument, may be selected through the menu system, or it may be requested automatically by the system (e.g. after completion of a delivery, or after a number of lifts have been carried out without zeroing). The zero-setting must be repeated every 15 minutes.

Zero is set (to within $\pm 0.25e$) by raising the empty load receptor a number of times (according to instructions on the display). When zero has been set, a zero symbol ">0<" is displayed.

1.14 Interfaces

Instruments may be fitted with interfaces for the connection of auxiliary and/or peripheral devices. Any interfaces shall comply with clause 4.2.4 of document NMI R51 (the basic intent of which is that it shall not be possible to alter weighing results via the interfaces).

Any measurement data output from the instrument or its interfaces shall only be used for trade in compliance with NMI General Supplementary Certificate of Approval No S1/0B (in particular in regard to the data and its format).

Indications other than the indications of measured mass (i.e. gross, tare, net, totals) displayed either on the indicator or on an auxiliary or peripheral device, are not for trade use.

Instruments may be fitted with RS-232, Ethernet, SD card, USB and CAN interfaces.

1.15 Display Check

A display check is initiated whenever power is applied.

1.16 Verification Provision

Provision is made for the application of a verification mark.

1.17 Sealing Provision

The instrument is sealed by recording the audit trail counter on verification.

Access to allow changing of set-up parameters including calibration parameters must be protected by a passcode.

The instrument automatically increments a configuration and/or calibration value (audit trail number) each time the instrument is re-configured and/or calibrated.

The value(s) of these counters may be recorded on a destructible adhesive label attached to the instrument (e.g. as Event Trail x). Any subsequent alteration to the calibration or configuration will be evident as the recorded values and the current counter values will differ.

The configuration and calibration audit trail may be accessed by pressing the  'Setup' key and then Event Trail is displayed as shown in Figure 8a.

Provision is made for access to the weighing module to be sealed by using two destructible labels placed over opposite sides of a join in the weighing module housing as shown in Figure 8b.

1.18 Software

The legally relevant software is designated as follows.

Software Type	Designation	Version Number
Weighing module	LX100	003
Isocan	IS100	005
Database	DBIS100	001

The instructions for accessing the legally relevant version are as follows (starting from the normal weighing mode):

- Press the  'Setup' key.
- Select the 'About System' key, then software information is displayed.

1.19 Descriptive Markings and Notices

Instruments carry the following markings:

Manufacturer's mark, or name written in full	RDS
Name or mark of manufacturer's agent
Indication of accuracy class	Y(b)
Pattern approval mark for the instrument	NMI 6/20A/6
Maximum capacity	Max kg #1
Minimum capacity	Min kg #1
Verification scale interval	e = kg #1
Serial number of the instrument

- #1 These markings shall also be shown near the display of the result if they are not already located there.

2. Description of Variant 1 **approved on 20/03/15**

The RDS model Loadmaster Alpha 100 class Y(b) automatic catchweighing instrument similar to the pattern but fitted to different wheeled loaders which may also have different maximum capacities.

Instruments are approved for use with up to 250 verification scale intervals.

3. Description of Variant 2 **provisionally approved on 20/03/15**
cancelled 22/10/15

The RDS model Loadmaster Alpha 100 class Y(b) automatic catchweighing instrument similar to the pattern and variant 1 but fitted to various forklifts of various maximum capacities.

4. Description of Variant 3 **approved on 19/04/17**

The RDS model Loadmaster Alpha 100 class Y(b) automatic catchweighing instrument similar to the pattern and variant 1 but fitted with a RDS Gyro sensor model S/SR/421-5-001 in the place of the bucket sensor (see clause 1.5). The system will inhibit weighing if the load receptor is outside of angular limits.

Instruments may be fitted with a RDS reference and direction sensor model S/SR/139-5-150 in the place of the boom angle sensor (see clause 1.4). The weighing process is activated at a certain linear position instead of angular position.

4.1 Software

The legally relevant software is designated as follows.

Software Type	Designation	Version Number
Weighing module	LX100	004
Isocan	IS100	006
Database	DBIS100	001

5. Description of Variant 4 **approved on 19/04/17**

The RDS model Loadmaster Alpha 100 class Y(b) automatic catchweighing instrument similar to variant 3 but fitted to various forklifts of various maximum capacities (Figure 9).

6. Description of Variant 5 **approved on 10/05/19**

The pattern or variants having Topcon model MKII Part No. S/SR/500-2-110 or Topcon model MKIII Part No. S/SR/500-2-120 Compact pressure sensors of 250 bar maximum range.

7. Description of Variant 6 **approved on 28/01/21**

The pattern or variants having legally relevant software as follows.

Software Type	Designation	Version Number
Weighing module	LX100	004
Isocan	IS102	001
Database	DBIS100	001

The instructions for accessing the legally relevant version are as follows (starting from the normal weighing mode):

- Press the  'Setup' key.
- Select the 'About System' key, then software information is displayed.

8. Description of Variant 7 **approved on 04/05/22**

The pattern or variants having Topcon model MK4 Part No. S/SR/500-2-131 Compact pressure sensors of 250 bar maximum range.

TEST PROCEDURE No 6/20A/6

Instruments shall be tested in accordance with any relevant tests specified in the National Instrument Test Procedures.

Maximum Permissible Errors

The maximum permissible errors are specified in Schedule 1 of the *National Trade Measurement Regulations 2009*.

FIGURE 6/20A/6 – 1

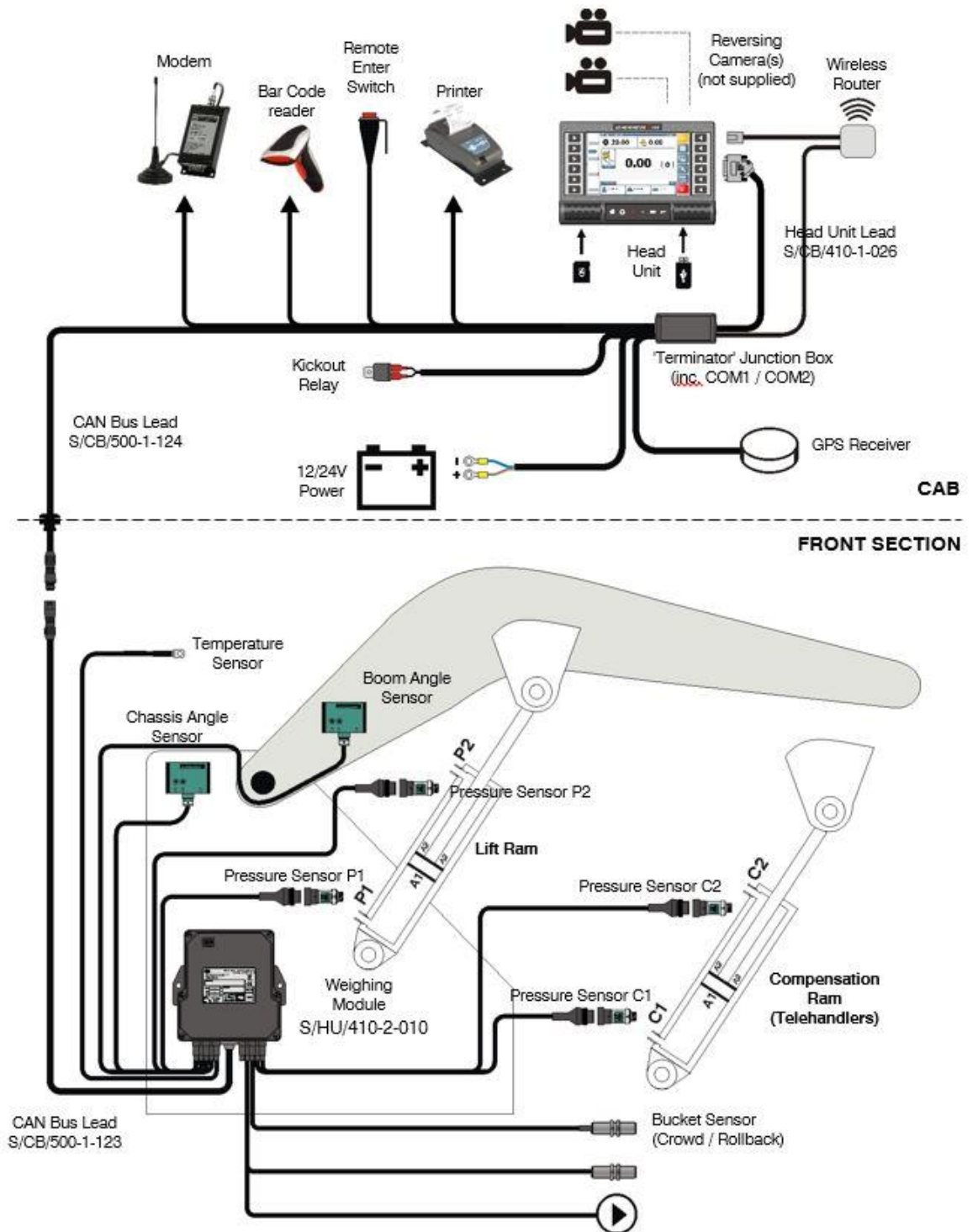

a) Typical RDS Model Loadmaster Alpha 100 Wheeled Loader Weighing Instrument System Overview (Pattern)

FIGURE 6/20A/6 – 1

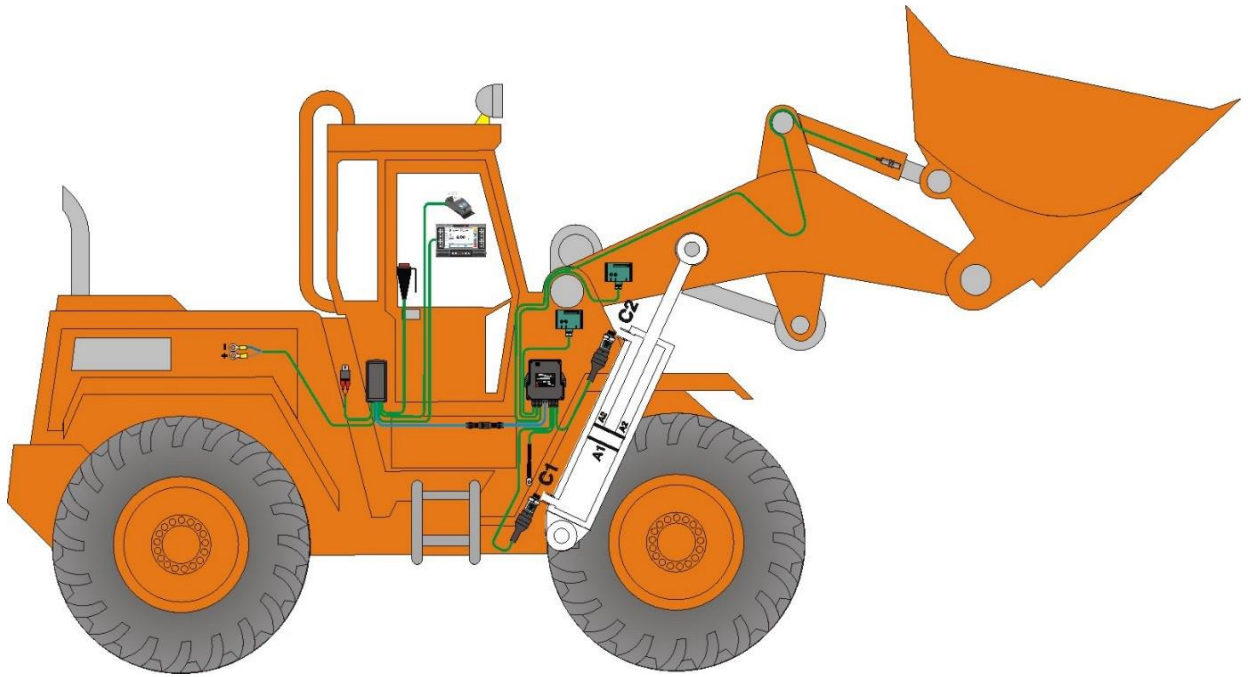

b) Typical RDS Model Loadmaster Alpha 100 Wheeled Loader Weighing Instrument (Pattern)

FIGURE 6/20A/6 – 2



Typical RDS Pressure Sensor Installation

FIGURE 6/20A/6 – 3

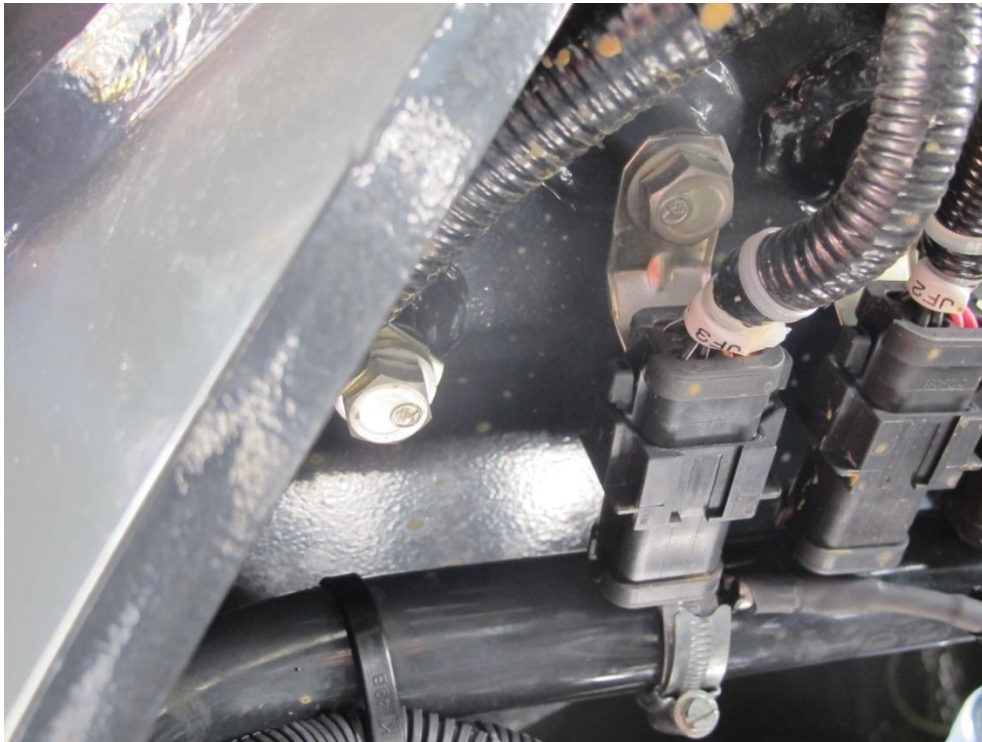

Temperature Sensor

FIGURE 6/20A/6 – 4



Bucket Sensor

FIGURE 6/20A/6 – 5

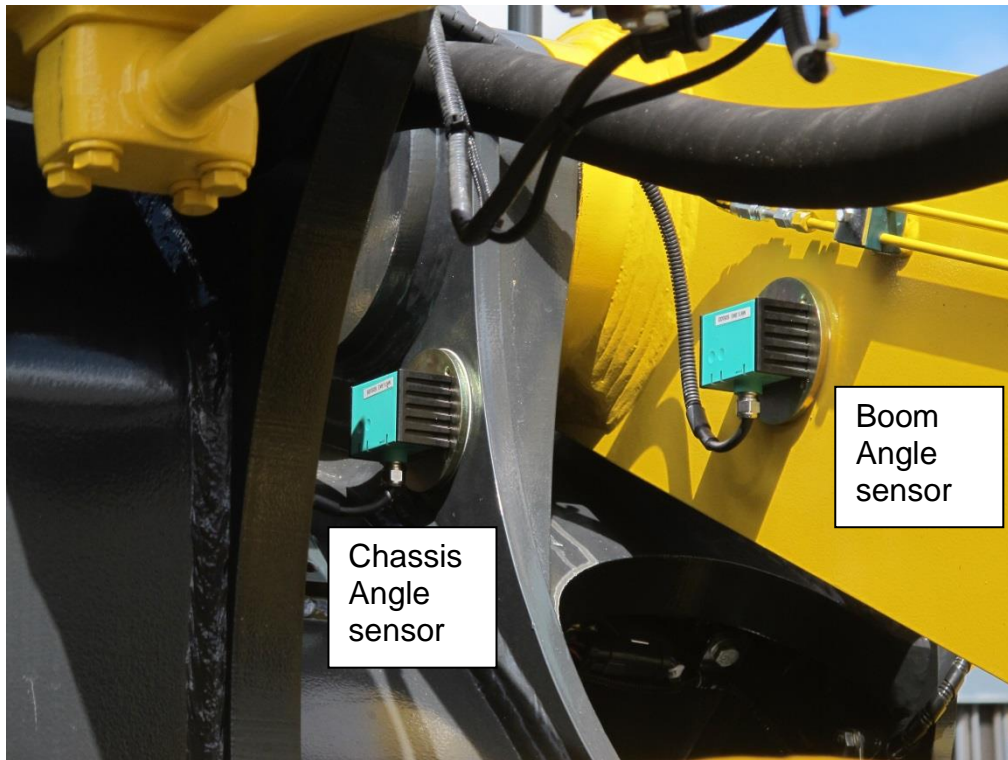

Boom and Chassis Inclinometers

FIGURE 6/20A/6 – 6



Weighing Module

FIGURE 6/20A/6 – 7



Loadmaster ISOCAN Control and Display Unit (Pattern)

FIGURE 6/20A/6 – 8

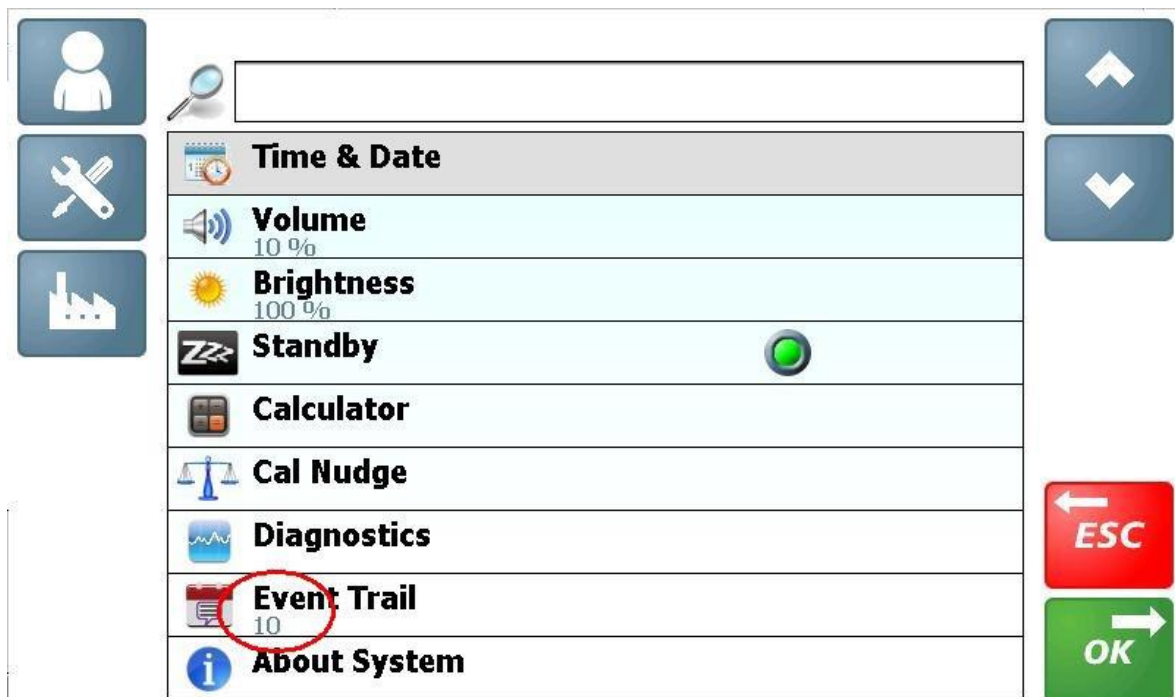

a) Audit Trail

FIGURE 6/20A/6 – 8

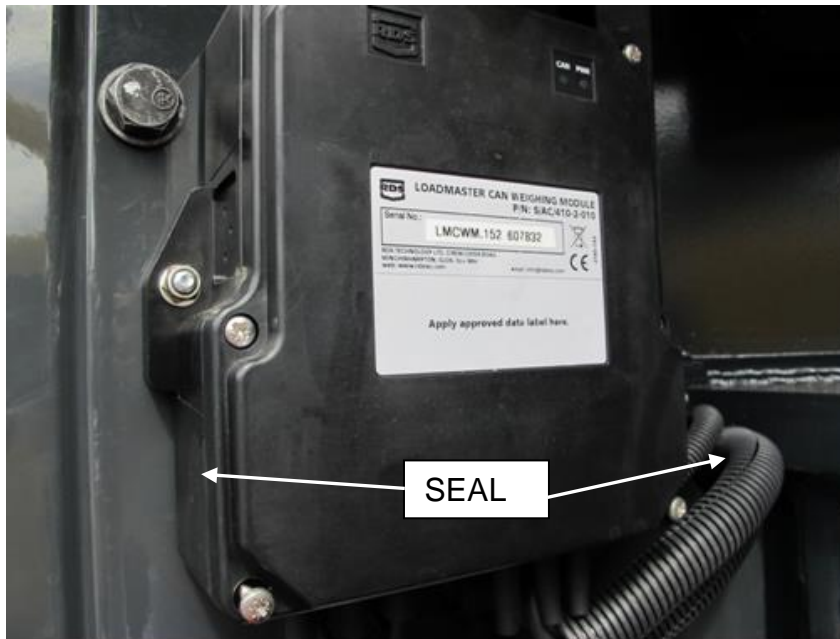

b) Typical Sealing of Weighing Module

FIGURE 6/20A/6 – 9

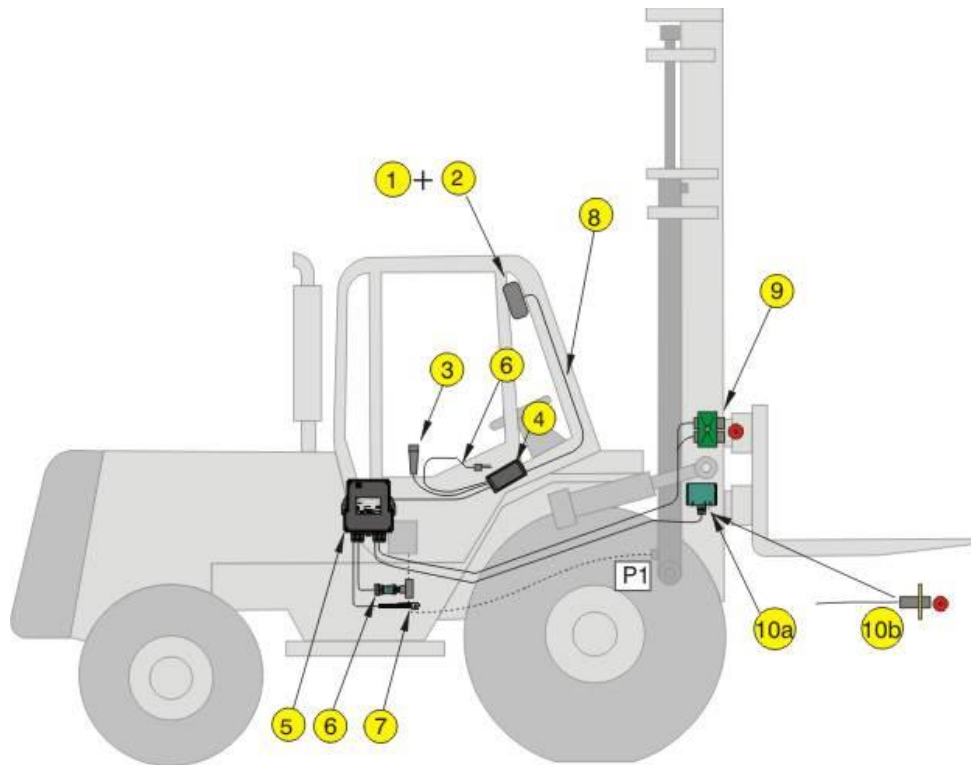

Component	Description	LM a100
1	Head Unit	<input type="checkbox"/>
2	Printer	<input type="checkbox"/>
3	Remote Enter Switch	Option
4	Cab "Terminator" connection box	<input type="checkbox"/>
5	Can Weighing Module	<input type="checkbox"/>
6	Power Supply	<input type="checkbox"/>
7	Oil Temperature Sensor	<input type="checkbox"/>
8	Instrument Connecting Cable	<input type="checkbox"/>
9	Reference/Direction Sensor + Magnet	<input type="checkbox"/>
10a	Inclinometer/Gyro	Option
10b	Fork/Bucket Sensor + Magnet	Option

Typical RDS Model Loadmaster Alpha 100 Forklift System Instrument
(Variant 4)

~ End of Document ~